

Article number: 0120049

Description: Retaining ring AL 32X1,5  
Spring steel

## Measures

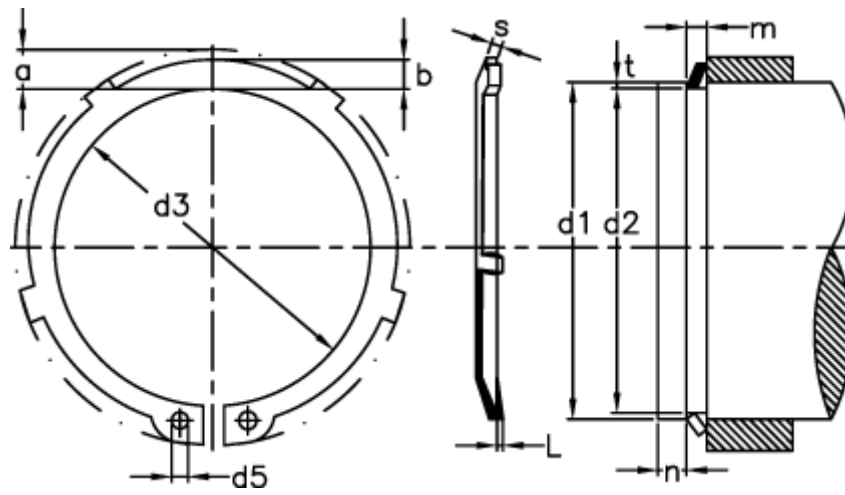

a max	= 5.0	FL max kN	= 0.90	s	= 1.50
b	= 3.6	FN kN	= 13.85	tol	= -0.25
C kN/mm	= 2.57	FRg kN	= 5.55	tol	= +0,21 -0,42
d1	= 32	FR kN	= 31.2	u	= 0.10
d2	= 30.3	g	= 2.0		
d3	= 29.6	L min	= 0.45		
d5 min	= 2.5	m min	= 1.60		
Description	= AL 32	Nominal drive	= 2.5		